

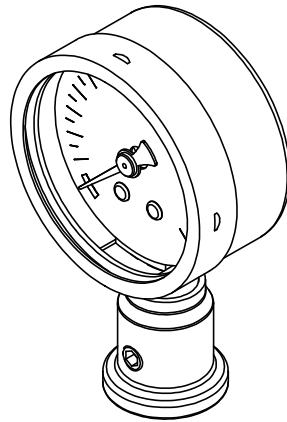

This drawing includes confidential information which is the property of ASHCROFT INC. This copy is loaned for a specific purpose, with the understanding that it will not be reproduced or used for any other purpose or disclosed to others, and it will be returned on demand.

**ASHCROFT** INC.

250 EAST MAIN STREET  
STRATFORD, CT 06614

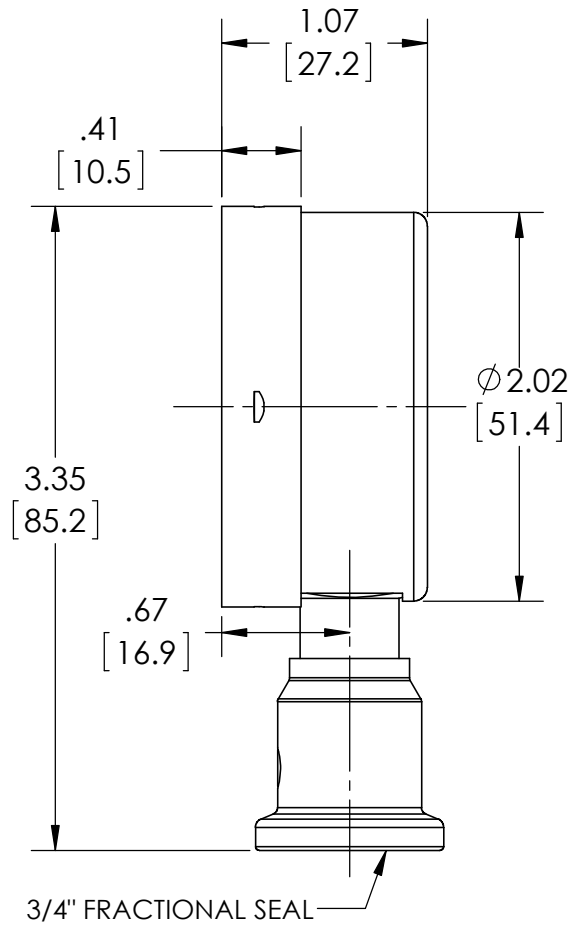
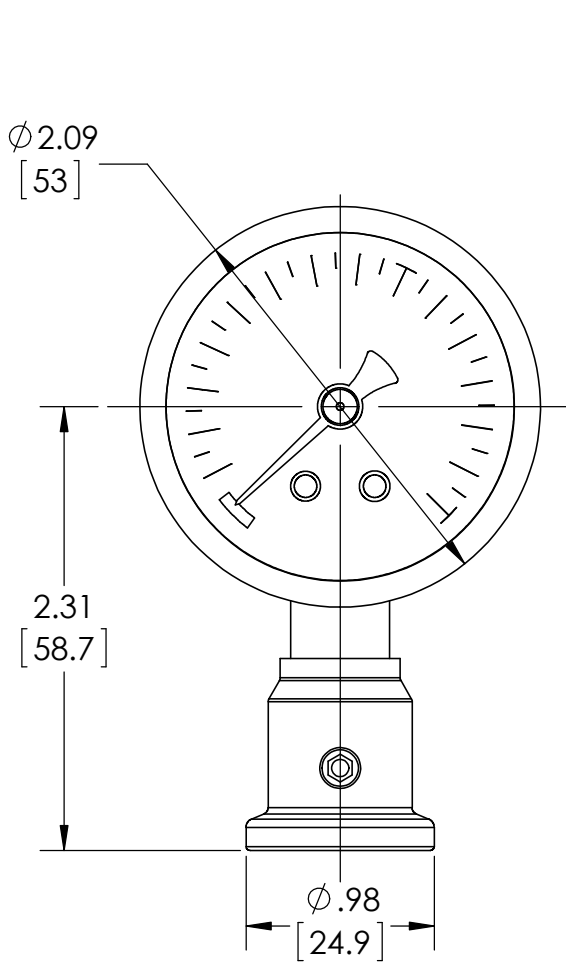

DIMENSIONS IN [ ] ARE MILLIMETERS

REV.	ECO	DESCRIPTION	BY	DATE
A	0004508	RELEASED GENERAL DIMS.	MJS	7/19/2011

This print certified correct for		<b>General Dimensions</b>		
Customer's Name		ASHCROFT 20 1032 75L SERIES		
		SANITARY GAUGE		
Customer's Order No.	Drawn MJS	Date 7/19/11	Date of Issue	
Ashcroft Order No.	Checked	Date	SHEET-1	Rev.
Certified by	Date	Approved	Date	<b>70A3086</b>
				<b>A</b>